



BEYAZLI GRUP



PLANT PRICE

16.775 EURO

VESS 4.1 MACHINE DAILY CAPACITY (8 HOURS) 3.750 CONCRETE HOLLOW BLOCK

FACTORY : TRABZON – ERZURUM DEVLET KARAYOLU ÜZERİ 9.Km. AKOLUK BELEDİYE KARŞISI – ÇAĞLAYAN / TRABZON / TURKEY
FACTORY:+90 462 357 30 62 /OFFICE :+90 462 321 07 78/GSM:+90 549 325 66 70/Web:www.veSSmachine.com/ Email : abdoul@beyazligroup.com

 Lütfen Bu Belgeyi Yazdırmadan Önce Çevreyi Düşünün./Please consider the environment before printing this document

PLANT INSTALLATION LAYOUT

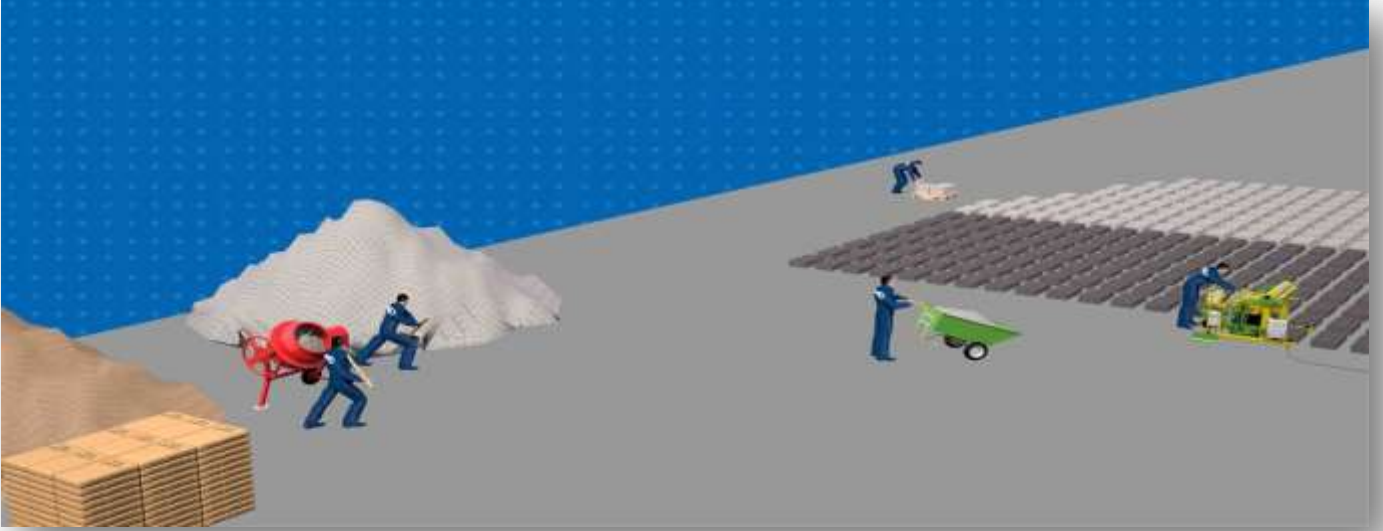

PLANT DESCRIPTION

VESS 4.1 FULLY AUTOMATIC- BLOCK MACHINE WHICH CAN PRESS WITHOUT PALLET.IT HAS FEATURE OF CREATING A FIELD TO BE MAKING PRESS ITSELF THANKS TO WALKING CAPABILITY. GETTING WITH THE PRE-PREPARED MORTAR,CAN PRODUCE ANY KIND OF BLOCKS-ASMOLEN-STRAPHORED BRICK AND GARDEN BORDERS WHICH ARE LOADED ON ITS. MACHINE IS DESIGNED WITH **FULLY AUTOMATIC** OPERATING SYSTEM. DESIGNED TO WORK 24 HOURS. WE HAVE PLANTS WITH DIFFERENT AUTOMATION SYSTEMS AND CAPACITIES. FOR FURTHER INFORMATION PLEASE CONTACT YOUR NEAREST CUSTOMER REPRESENTATIVE.

EQUIPMENT LIST WITH PRICES, PREPARED RELATED TO THE NUMBERED INSTALLATION LAYOUT IS GIVEN BELOW. SAMPLE LAYOUT IS PREPARED AS TURNKEY PROJECT TO COMPLETE PLANT. CONTAINED EQUIPMENTS CAN BE REMOVED, REDUCED OR TO BE INCREASED OPTIONALLY. (Please visit our website and ask for offer)

FOR A PLANT WITH THESE FEATURES THE RECOMMENDED CURING AND STOCK AREA SHOULD BE MINIMUM **1.500 m²**. THERE IS NO OBLIGATION FOR ROOFING. THE PREPARED CONCRETE FLOOR SHOULD BE MINIMUM **1/2** OF THE TOTAL PLANT AREA.

4.1 FULLY AUTOMATIC MACHINE SHIPPING VOLUME

1 PIECE 20'Ft HQ CONTAINER

PRODUCT DESCRIPTION ACCORDING TO THE PLANT INSTALLATION LAYOUT

(01) – VESS 4.1 FULLY AUTOMATIC (EGG LAYING) BRICK MACHINE



MACHINE GENERAL PROMOTION

- ▶ HAVE HIGH PRODUCTION CAPACITY WITH LESS EMPLOYEE.
- ▶ ALL KINDS OF SPARE PARTS CAN BE FOUND EASILY.
- ▶ ELECTRIC CONSUMPTION IS MINIMUM LEVEL.
- ▶ CAN BE MOVED AND INSTALLED EASILY.
- ▶ YOU CAN MAKE OUR PRODUCTION IN THE ORDERED SITE.
- ▶ LOW NOISE WITH SILENT ENGINE PUMPS.
- ▶ FIREPROOF ELECTRICAL CABLE OWNER.
- ▶ MOLD CAN BE CHANGED EASILY IN SHORT TIME
- ▶ DO NOT REQUIRE TECHNICAL ASSISTANCE FOR INSTALLATION.
- ▶ SMOOTH SURFACE THROUGH PRODUCING WITH FINE AGGREGATE.
- ▶ FACILITY PRODUCTION POSSIBILITY WITH ADDED OPTIONAL EQUIPMENTS.
- ▶ OPTIONALLY WORKS STATIONARY. (PALLET PRODUCTION CAPABILITY)





MACHINE WORKING

▶ WALKING MOVEMENT AUTOMATIC	▶ VIBRATION AUTOMATIC SENSOR
▶ PRODUCT HEIGHT FIXTURE	▶ WARNING SIREN DURING MOTION
▶ MALE MOLD MOVEMENT BY AUTOMATIC SENSOR	▶ ADJUSTABLE PRESSING SYSTEM
▶ ROTATION MOTION OPERATOR CONTROLLED	▶ MORTAR LOADING MANUAL
▶ WASTE PLATE FOR OVER MORTAR	▶ OIL LEVEL INDICATIVE
▶ LIFE SIZE ABSORBER WHEELS	▶ EMERGENCY STOP BUTTON FOR SAFETY
▶ HYDRAULIC SYSTEM AIR FILTER - RECYCLED	▶ CLEANS PRODUCTION FACILITY AREA ITSELF

ADDITIONAL EQUIPMENT

STONE FORM WORK AND EQUIPMENT WITH EMBOSSED SURFACE (ONE PRODUCT EACH PRESS)

MANUAL COLLECTING ROBOT // FIXING APPARAT (RETURN TO PALLET SYSTEM)

STRAPHORED BRICK MOLD // GENERATOR // COMPRESSOR // TRANSPALLET

AWNING (FOR PROTECTING MACHINE FROM EXTERNAL EFFECTS)

220V OR 380V ENGINE OPTION

FACTORY : TRABZON – ERZURUM DEVLET KARAYOLU ÜZERİ 9.Km. AKOLUK BELEDİYE KARŞISI – ÇAĞLAYAN / TRABZON / TURKEY
FACTORY:+90 462 357 30 62 /OFFICE :+90 462 321 07 78/GSM:+90 549 325 66 70/Web:www.vessmachine.com/ Email : abdoul@beyazligroup.com



Lütfen Bu Belgeyi Yazdırmadan Önce Çevreyi Düşünün./Please consider the environment befor eprinting this document

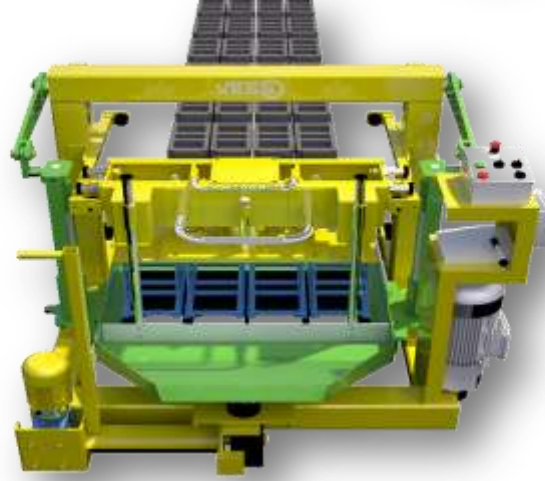

MACHINE TECHNICAL DETAILS



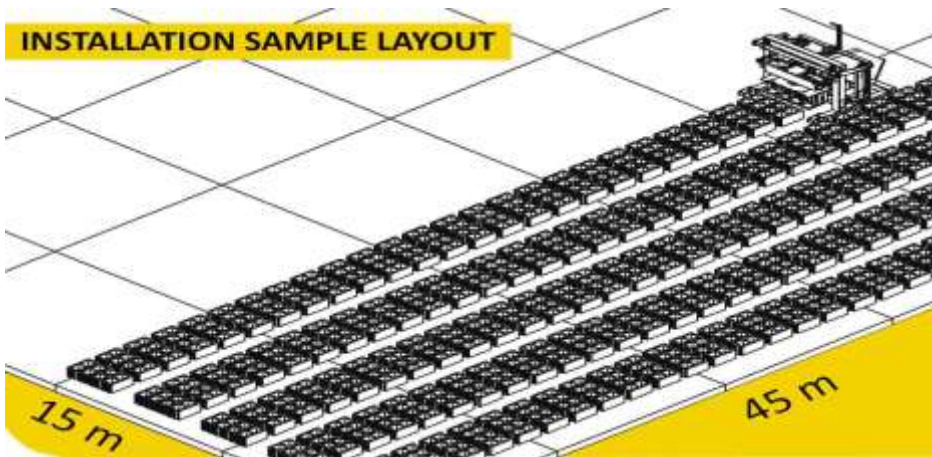







CONTROL METHOD	FULLY AUTOMATIC	HYDRAULIC TANK	70 Lt
MOTOR QUANTITY	4 PIECES	HYDRAULIC PRESSURE	65 Bar
TOTAL ENGINE POWER	4 Kw	TOTAL WEIGHT	680 Kg
VIBRATION QUANTITY	DOUBLE VIBRO MOTOR	EXTERNAL MEASUREMENTS	165x135x110 cm
VIBRATION POWER	2 X 475 Kg	ELECTRIC CABLE (SOCKED)	50 mt
VIBRATION CYCLE TIME	20 SECOND	PERSONAL NUMBER (FOR PRODUCTION)	4 PERSON
COMPRESS TYPE	TORSION (COMPRESSING WITH SPRING)	PRODUCTION AREA (RECOMMENDED)	675 m ² (15 x 45)
PRODUCED PRODUCTS	18-20 cm HEIGHT	AGREGA (RECOMMENDED)	5 mm



NOT: PRODUCTION AREA PLACEMENT, **MANUAL MACHINES:** THE MACHINE LAYING WITH 5 cm GAP IN ORDER TO FORWARD, SIDEWARDS WITH 35 cm GAP. **AUTOMATIC MACHINES** THE MACHINE LAYING WITH IN ORDER TO FORWARD 20 cm GAP, SIDEWARDS WITH 35 cm. FOR THE MANUAL MACHINES RECOMMENDED CONCRETE AREA IS MIN 15x45 METER.



PRODUCTION CAPABILITY IN ONE PRESS

 (6 PIECES)	HOLLOW BLOCK - 10 cm 10 x 40 x h:20	 (2 PIECES)	HOLLOW BLOCK - 30 cm 30 x 40 x h:20
 (5 PIECES)	HOLLOW BLOCK - 12 cm 12 x 40 x h:20	 (4 PIECES)	ASMOLEN- 20 cm 20 x 40 x h:20
 (5 PIECES)	HOLLOW BLOCK - 15 cm 15 x 40 x h:20	 (4 PIECES)	STRAPHORED BRICK - 20 cm 20 x 40 x h:20
 (4 PIECES)	HOLLOW BLOCK - 20 cm 20 x 40 x h:20	 (1 PIECES)	EMBOSSED STONE - 20 cm 20 x 40 x h:20
 (3 PIECES)	HOLLOW BLOCK - 25 cm 25 x 40 x h:20	 (2 PIECES)	CURBSTONE - 50 cm 12 x 50 x h:20

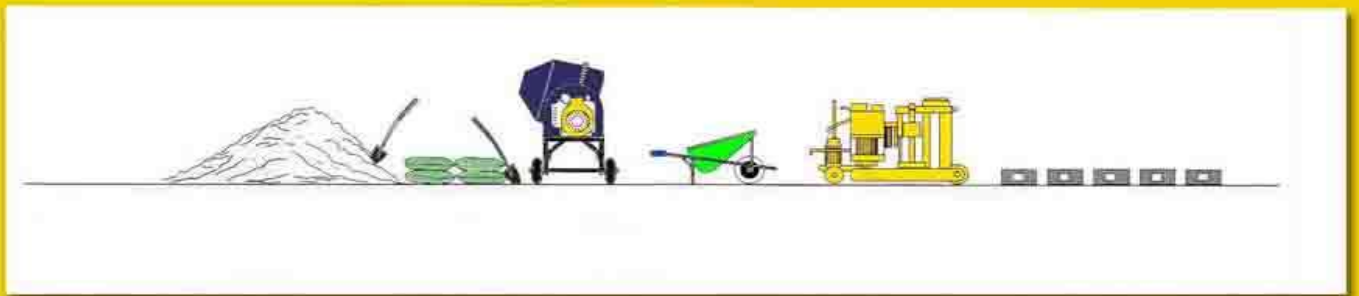
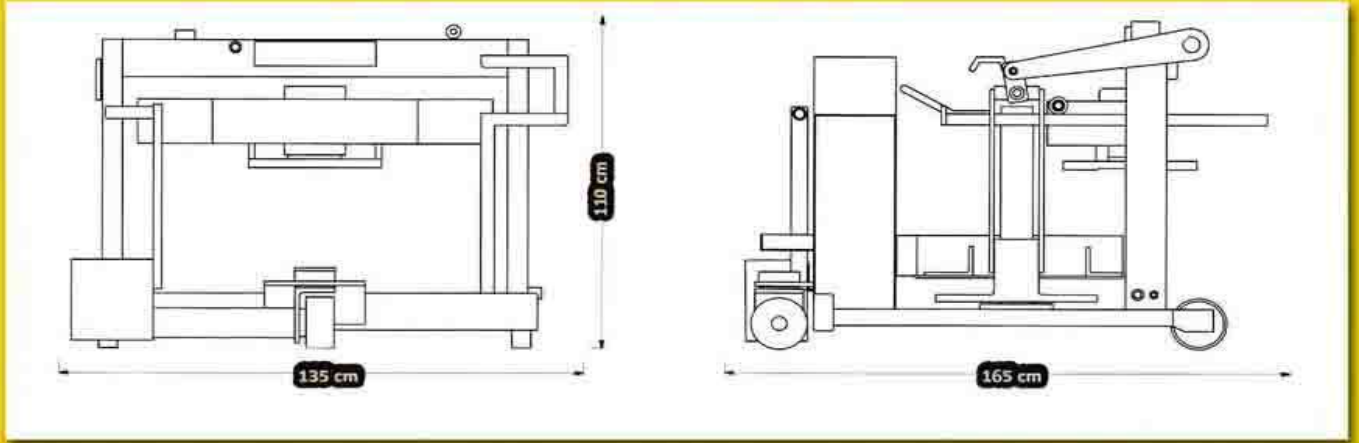

(02)– MORTAR MIXING CONCRETE MIXER



THE EQUIPMENT TO PREPARE MIXTURE FOR THE PRODUCT TO BE PRESSED. 380-400 lt CAPACITY. CHANGEABLE GEAR EXIST. THERE IS A TAMBOUR BASE REINFORCED WITH STEEL BEAM. PROTECT WITH SAFE ELECTRICAL INSULATION. INNER HANDLES MAKE HOMOGENEOUS MIXTURE. UPPER AND LOWER PART OF TAMBUR CAN BE CHANGED SEPERATELY. MIXER DRIVE AND PULLEY CONCRETE BEARINGS PRODUCED BY QUALITY BEARINGS. EASY TO DISCHARGE WITH CONIC TAMBOUR. MIXER DOES NOT NEED MAINTENANCE.

(03)– MORTAR CARRIER



EQUIPMENT TRANSFERS THE MIXTURE (MORTAR) FOR THE PRODUCT TO BE PRESSED TO THE MACHINE.

PRODUCT FEATURES

- PIPE THICKNESS 32/1.50 MM
- CASE THICKNESS 0,80 MM
- SPECIAL CASE EDGE BENDING SYSTEM
- 85 LT. CASE VOLUME
- DUBLEX WHEELED
- BOAT / ST 52-A1 STEEL SHEET
- DEMOUNTE (BOLTED) SYSTEM



(04)– SPIRAL ELECTRIC TRANSFER CABLE (SOCKET)



CABLE SYSTEM TRANSFERS ENERGY COMING FROM ELECTRIC NETWORK TO THE MACHINE. IT IS USED ENOUGH AMOUNT FOR THE PRODUCTION AREA. INCLUDING SPIRAL PROTECTION IN ORDER TO NOT TO BE AFFECTED BY MACHINES FEEDING MOVES. WITH THIS PROTECTION IT MOVES EASILY TO WANTED AREA.MECHANICAL STRESS RESISTANT.SPIRAL CABLES ARE RETRACTABLE TO PREVENT MESS.

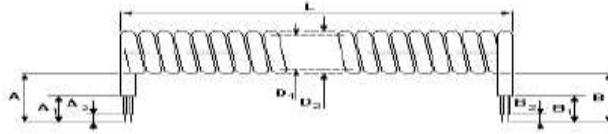

(05) – MORTAR THROWING SHOVEL



EQUIPMENT FILLING MORTAR COMING FROM THE MIXER BY WHEELBARROW TO THE MORTAR HOPPER. HANDLE SYSTEM DESIGNED TO MOVE IT EASILY. METAL WHICH IS LOCATED IN THE END OF PART HAS A CURVATURE OF 90 DEGREES AND ALLOWS THE MOLD TO FILL THIS GAP IN A SHORT TIME.PREFERRED ABRASION RESISTANT AND LIGHT MATERIAL BECAUSE OF THE CONTACT WITH MORTAR.

(06) – DIFFERENT TYPES BRICK MOULDS (ST 52)

STEEL CONSTRUCTION MOULDS : AFTER DESIGNING THE MOULDS DIMENSIONS WILL BE BROUGHT TO THE DESIRED VALUE USING WEAR RESISTANT SPECIAL SHEET METAL WITH STEEL CONSTRUCTION SYSTEM. CURBSTONE MOULD BLADES ARE READY TO USE AFTER SAWDUST REMOVAL PROCESSING FROM THE CK 45 SHEET METALS AND HARDENINGS PROCESS VIA INDUCTION.



(07) – ELECTRICAL UNIT / AUTOMATION

MACHINE ELECTRICAL PANEL; OPERATING SYSTEM EXIST OF COLLECTED POWER AND CONTROL PANELS GATHERED IN ONE UNIT . DESIGNED ACCORDING TO OPERATION ORDER. THERE ARE STOP BUTTONS TO INTERVENE IN CASE OF EMERGENCY. THE USED PARTS ARE TELEMECANIC AND SIEMENS BRANDS. INDEPENDENT PROTECTION INSURANCE FOR EACH ENGINE.USED SCHNEIDER BRAND TIMER.



SAMPLE CONCRETE HOLLOW BLOCK MODELS



COMMERCIAL TERMS

- **CODE : V-041** THIS CAMPAIGN IS VALID UNTIL 30.06.2019. DELIVERY TIME ; MAXIMUM 21 WORKING DAYS. OPERATOR TRAINING ; TRAINING AND OPERATOR CERTIFICATE WILL BE PROVIDED FREE OF CHARGE.
- **INFRASTRUCTURE PROJECT** ; WILL BE PROVIDED THROUGH OUR COMPANY FREE OF CHARGE AFTER DISCOVERING AND SOME NECESSARY STUDIES ARE MADE.
- **COMMISSIONING AND TEST PRODUCTION** ; THE EXPENSES FOR VISA (IF NECESARRY) FOR THE TECHNICAL TEAM - FLIGHT TICKETS - TRANSFER - ACCOMODATION AND HYDRAULIC OIL FOR THE MACHINE WILL BE PAID BY THE PURCHASER.
- **SHIPPING** ; CAMPAIGN PRICES ARE FACTORY DELIVERY (EX-WORKS). SHIPPING AND ALL INSURANCE COSTS ARE FOR THE PURCHASER, LOADING COSTS ARE FOR THE SELLER. OUR COMPANY PROVIDES ALL LOGISTICAL SUPPORT FOR THE SHIPMENT OF THE CUSTOMERS. **TAXES** ; BY DOMESTIC SALES 18% , INCENTIVE AND LEASING 1% APPLIED. BY OVERSEA SALES TAXES ARE NOT REQUIRED.
- **METHOD OF PAYMENT** ; 30% DOWNPAYMENT BY ORDERING AFTER SIGNING OF THE OFFICIAL CONTRACT, INTERIM PAYMENT OF 30% AND REMAINDER 40% BY DELIVERY VIA BANK TRANSFER. ALL OF OUR PRODUCTS ARE SUITABLE FOR SALE VIA L/C - BANK LOAN AND LEASING.
- **OUR AGREEMENTS** ; ARE APPROVED BY CHAMBER OF INDUSTRY AND TRADE FOR DOMESTIC SALES, BY OVERSEAS SALES APPROVED BY THE EXPORTERS UNION. IT HAS THE INTERNATIONAL NORMS AND VALIDITY.
- **WARRANTY** ; ALL OF OUR PRODUCTS ARE UNDER WARRANTY AGAINST MANUFACTURING FAILURES FOR A PERIOD OF 2 YEARS. OPTIONALLY WARRANTY PERIOD CAN BE EXTENDED UPTO 2 + 3 = 5 YEARS BY ADDING THE PRICE DIFFERENCE OF 5%
- **AFTER SALES AND SPARE PARTS** ;BY POSSIBLE FAILURES THE INTERVENE TIME IS DOMESTIC 48 HOURS - INTERVENE TIME GLOBALLY IS MAXIMUM BETWEEN 72 AND 120 HOURS. THIS TIME SCHEDULE IS NOT RELEVANT FOR COUNTRIES WHICH ARE REQUESTING A INVITATION FOR VISA. OUR WARRANTY COMMITMENTS ARE SIGNED BY THE OFFICIAL FORMAL CONTRACT.



PHOTO GALLERY



FACTORY : TRABZON – ERZURUM DEVLET KARAYOLU ÜZERİ 9.Km. AKOLUK BELEDİYE KARŞISI – ÇAĞLAYAN / TRABZON / TURKEY
FACTORY:+90 462 357 30 62 /OFFICE :+90 462 321 07 78/GSM:+90 549 325 66 70/Web:www.vessmachine.com/ Email : abdoul@beyazligroup.com

 Lütfen Bu Belgeyi Yazdırmadan Önce Çevreyi Düşünün./Please consider the environment befor eprinting this document

CONTACT

TURKEY 	
Contact Person:	Gökhan Özdemir
Cell :	+90 (549) 325 66 67
Phone :	+90 (543) 868 53 04
E-mail:	gokhan@beyazligroup.com

RUSSIA 	
Contact Person:	Tolga Kalelioğlu
Cell :	+90 (549) 325 66 62
Phone :	+90 (462) 321 07 78
E-mail:	tolga@beyazligroup.com

FRANCE 	
Contact Person:	Mohamed Thiam
Cell :	+90 (549) 325 66 60
Phone :	+90 (462) 321 07 78
E-mail:	mohamed@beyazligroup.com

LIBYA 	
Contact Person:	Mouad Mazour
Cell :	+218 (911) 620 035
Phone :	+90 (541) 868 54 59
E-mail:	mouad@beyazligroup.com

GEORGIA 	
Contact Person:	Lasha Gabaidze
Cell :	+995 (571) 912 626
Phone :	+90 (549) 325 66 64
E-mail:	lasha@beyazligroup.com

SAUDI ARABIA 	
Contact Person:	Abdurrahim Temur
Cell :	+90 (544) 549 41 99
Phone :	+90 (462) 321 07 78
E-mail:	temur@beyazligroup.com

AZERBAIJAN 	
Contact Person:	Anar Nazarov
Cell :	+994 (702) 002 677
Phone :	+90 (549) 325 66 61
E-mail:	gokhan@beyazligroup.com

UKRAINE 	
Contact Person:	Tolga Kalelioğlu
Cell :	+90 (549) 325 66 62
Phone :	+90 (462) 321 07 78
E-mail:	tolga@beyazligroup.com

OMAN 	
Contact Person:	Abdurrahim Temur
Cell :	+90 (544) 549 41 99
Phone :	+90 (462) 321 07 78
E-mail:	temur@beyazligroup.com

ALGERIA 	
Contact Person:	Mouad Mazour
Cell :	+90 (541) 868 54 59
Phone :	+90 (462) 321 07 78
E-mail:	mouad@beyazligroup.com

AFRICA 	
Contact Person:	Abdoul Wahabou
Cell :	+90 (549) 325 66 70
Phone :	+90 (462) 321 07 78
E-mail:	abdoul@beyazligroup.com

MOROCCO 	
Contact Person:	Soumia Boukebir
Cell :	+90 (549) 325 66 69
Phone :	+90 (462) 321 07 78
E-mail:	soumia@beyazligroup.com



www.beyazligroup.com /// www.veismachine.com /// abdoul@beyazligroup.com

FACTORY : TRABZON – ERZURUM DEVLET KARAYOLU ÜZERİ 9.Km. AKOLUK BELEDİYE KARŞISI – ÇAĞLAYAN / TRABZON / TURKEY
 FACTORY:+90 462 357 30 62 /OFFICE :+90 462 321 07 78/GSM:+90 549 325 66 70/Web:www.veismachine.com/ Email : abdoul@beyazligroup.com

 Lütfen Bu Belgeyi Yazdırmadan Önce Çevreyi Düşünün./Please consider the environment befor eprinting this document